

RONDO DUO® EXPOSED GRID CEILING SYSTEM

SUMMARY

Rondo DUO® is a practical ceiling system which has a complete range of main sections and complementary parts so that you can adapt the modules to suit your design needs.

Expertly engineered for fast assembly on site, Cross Tees will positively lock into each other through the Main Tee with a gentle push, to create a sturdy structure for your ceiling requirements.

SUITABLE FOR:

- Steel Ceiling Grid Systems
- Aluminium Ceiling Grid Systems
- Drop-in Configurations
- One-way semi-concealed configurations
- Seismic Designs*
- Bulkhead designs
- Lineal diffusers

SPECIAL FEATURES

- Available in pre-finished steel
- Double rows of embossed stitching on tees to increase torsional strength
- Able to be removed/reinstalled without damage
- Main tee slots every 100mm for Cross Tees gives extra layout flexibility
- Unique “Zipper” box, better protects and stores product

IN PRACTICE

Since the early 2000s, we’re proud to have supplied the Rondo DUO® system to countless prestigious projects around Australia and the world, including the *Fiona Stanley Hospital* in Perth, and *RMIT Swanston University* in Melbourne.

* Seismic activity varies significantly in the markets where the Rondo DUO® System may be installed and therefore Rondo's Technical Services Department should be contacted for assistance.

IMPORTANT NOTE:

Rondo recommends its products and systems are installed by a qualified tradesperson and according to the relevant codes and standards outlined on page [256](#) of this manual.

CONTENTS:

COMPONENTS [40](#)

TYPICAL APPLICATION DETAILS [42](#)

INSTALLATION DETAILS:

• TWO-WAY EXPOSED GRID SYSTEM [45](#)

• EXPOSED GRID BULKHEAD SYSTEM [49](#)

• CONCEALED VERTICAL BULKHEAD SYSTEM [50](#)

PRODUCT DATA SPECIFICATIONS [51](#)

STANDARD GRIDS [53](#)

ALUMINIUM CEILING SYSTEM

• ALUMINIUM COMPONENTS [56](#)

• TYPICAL APPLICATION & INSTALLATION DETAILS [57](#)

• ALUMINIUM STANDARD GRIDS [60](#)

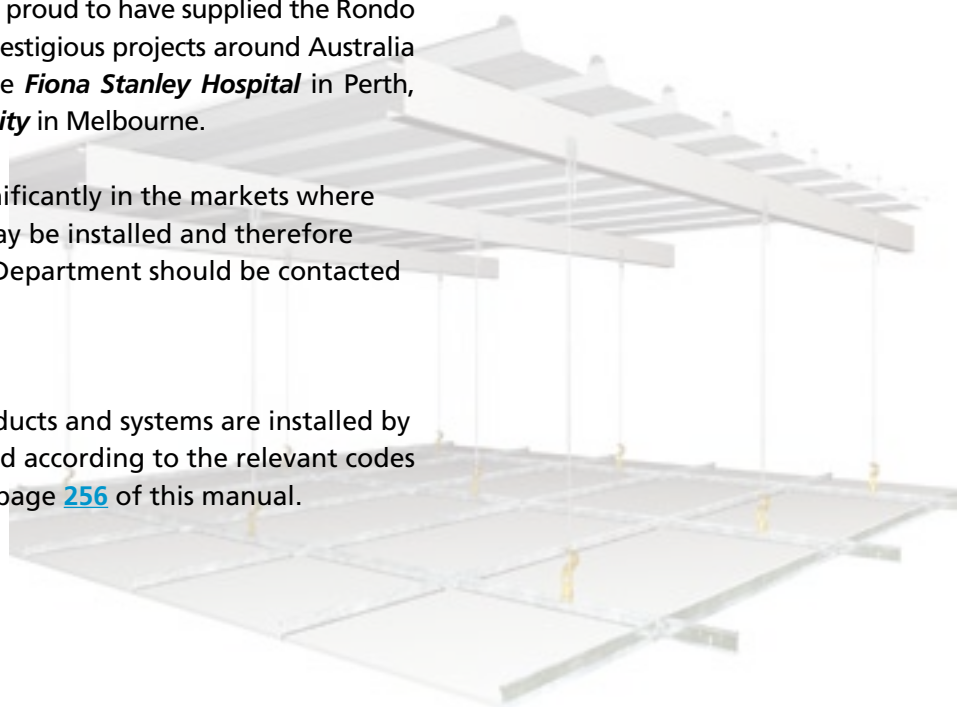

RONDO DUO® COMPONENTS

PRIMARY SECTIONS

DUO 1	Main Tee: 24 x 38mm
DUO 2	Cross Tee: 24 x 34mm
DUO H	Cross Tee: 24 x 34mm Heavy Duty

SPLINES

371	22mm T Spline
743	T Spline Yoke for DUO 1

WALL ANGLES & BULKHEAD TRIM

DUO 5	Rolled Edge Wall Angle: Steel 25 x 19mm
DUO 6	Shadowline Wall Angle: Steel 19 x 9 x 9 x 15mm
DUO 7	Shadowline Wall Angle: Aluminium 19 x 9 x 9 x 15mm
DUO 8	Aluminium Wall Angle: 32 x 19mm
321	Aluminium Bulkhead Clip

JOINERS

708	Tee Bar Bulkhead Clip
709	Joiner: DUO 5
716	Joiner: DUO 6 and 7
717	DUO 5 Bulkhead Clip

SUSPENSION CLIPS & BRACKETS

700	Spring adjustable clip for 5mm soft galv suspension rod
701	Thread adjustable clip for M6 threaded rod (with lock nut)
719	Hooked adjustable suspension clip
254	Suspension rod joiner
247	Suspension rod Angle Bracket
274	Suspension rod bracket
534	Suspension rod bracket: Timber – Steel
547	Suspension rod bracket: Concrete

PRIMARY SECTIONS



SPLINES

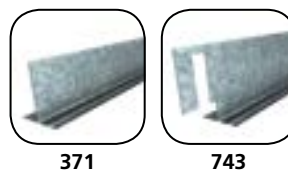

WALL ANGLES & BULKHEAD TRIM



JOINERS

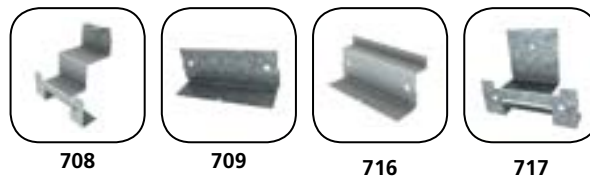

SUSPENSION CLIPS & BRACKETS

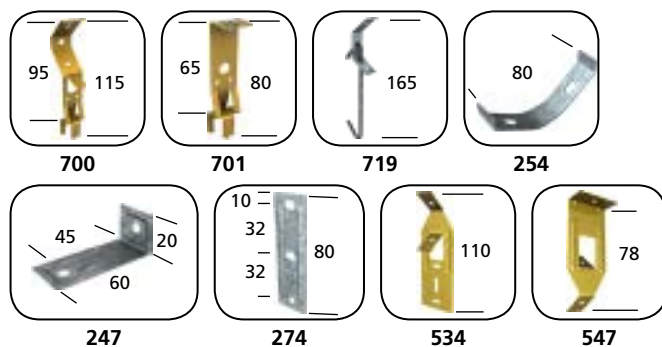

DIRECT FIXING CLIP

702	127mm direct fixing hanger to timber/steel
-----	--

DIRECT FIXING CLIP

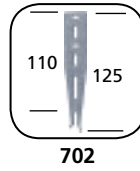

SUSPENSION RODS & NUTS

121	5mm soft galv. rod: plain
122	5.3mm soft galv. rod: M6 threaded one end
826	M6 nut to suit threaded rod

SUSPENSION RODS & NUTS

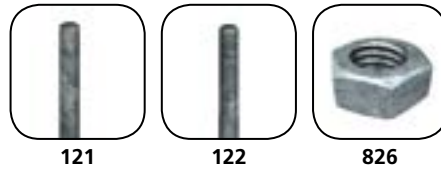

ACCESSORIES

703	Tile holddown clip for 10mm to 16mm tiles
704	Partition mounting clip: 51-64-76-92-150 stud walls
705	Stabiliser clip to suit DUO 5 and DUO 8 main/Cross Tees
706	Stabiliser clip to suit DUO 6 and DUO 7 main/Cross Tees
707	Interchange clip: 127/DUO 1

ACCESSORIES

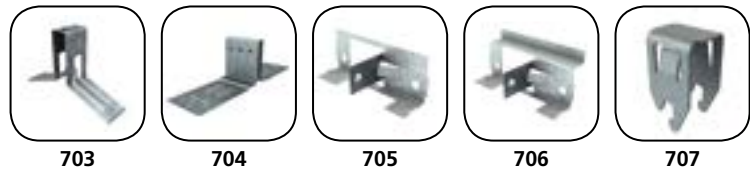

AIR DIFFUSER CLIP

713	3-Tee Bar: 50mm centres
-----	-------------------------

LINEAR AIR DIFFUSER CLIP



The details shown herein are generic in nature and do not specifically consider seismic design. For Seismic compliance refer to the Rondo "Introduction to Rondo Seismic Wall and Ceiling Systems" manual

TYPICAL APPLICATION DETAILS

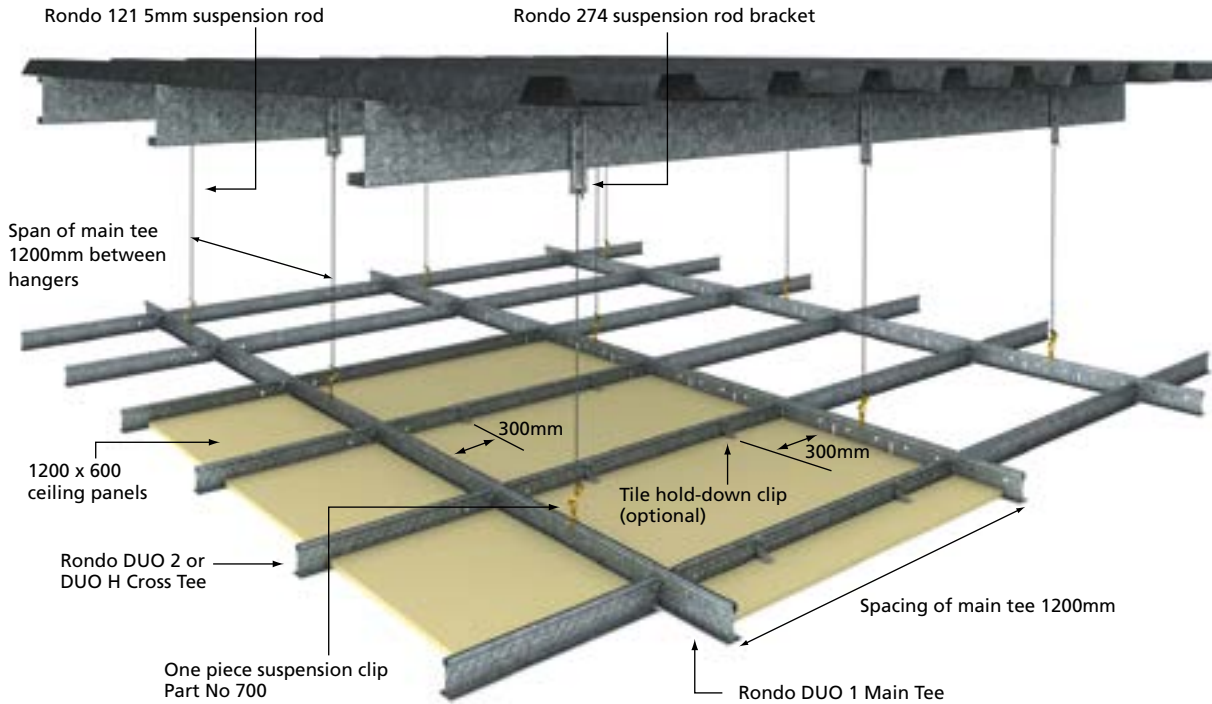

■ TWO-WAY EXPOSED CEILING SYSTEM DETAIL

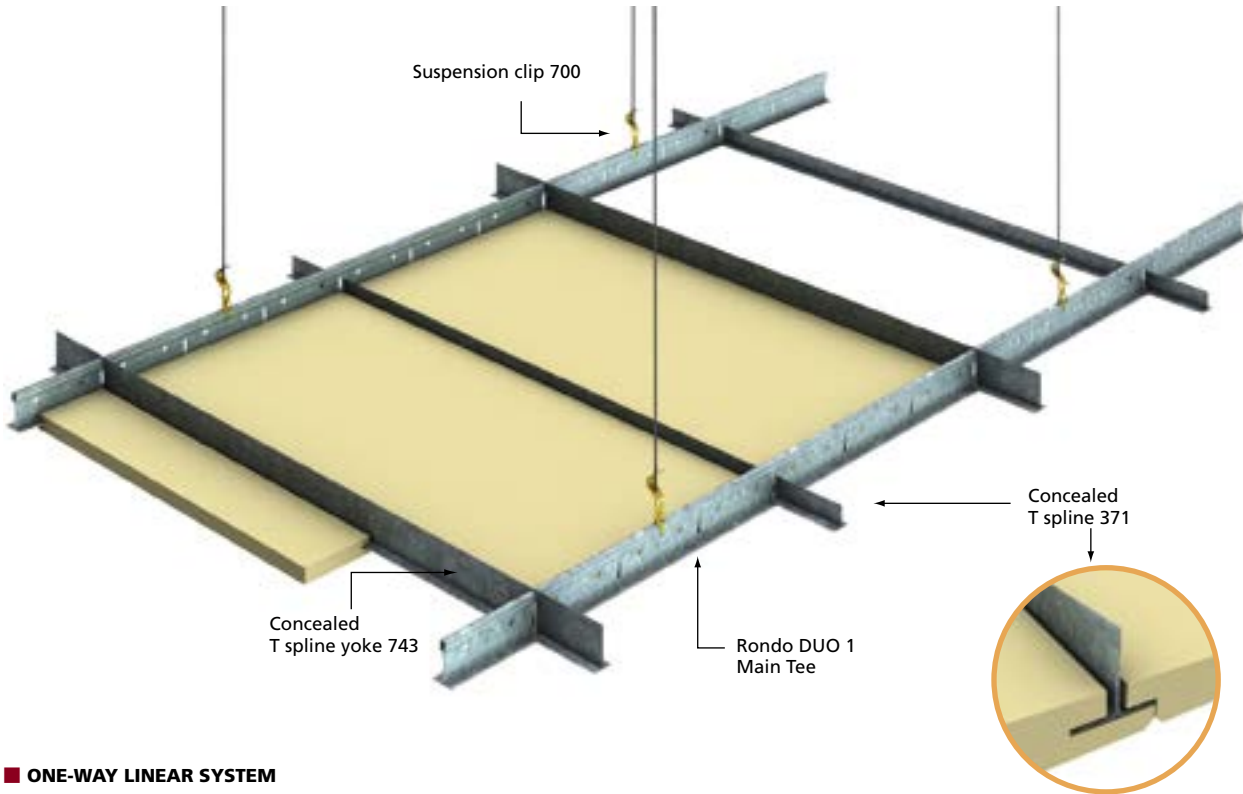

■ ONE-WAY LINEAR SYSTEM

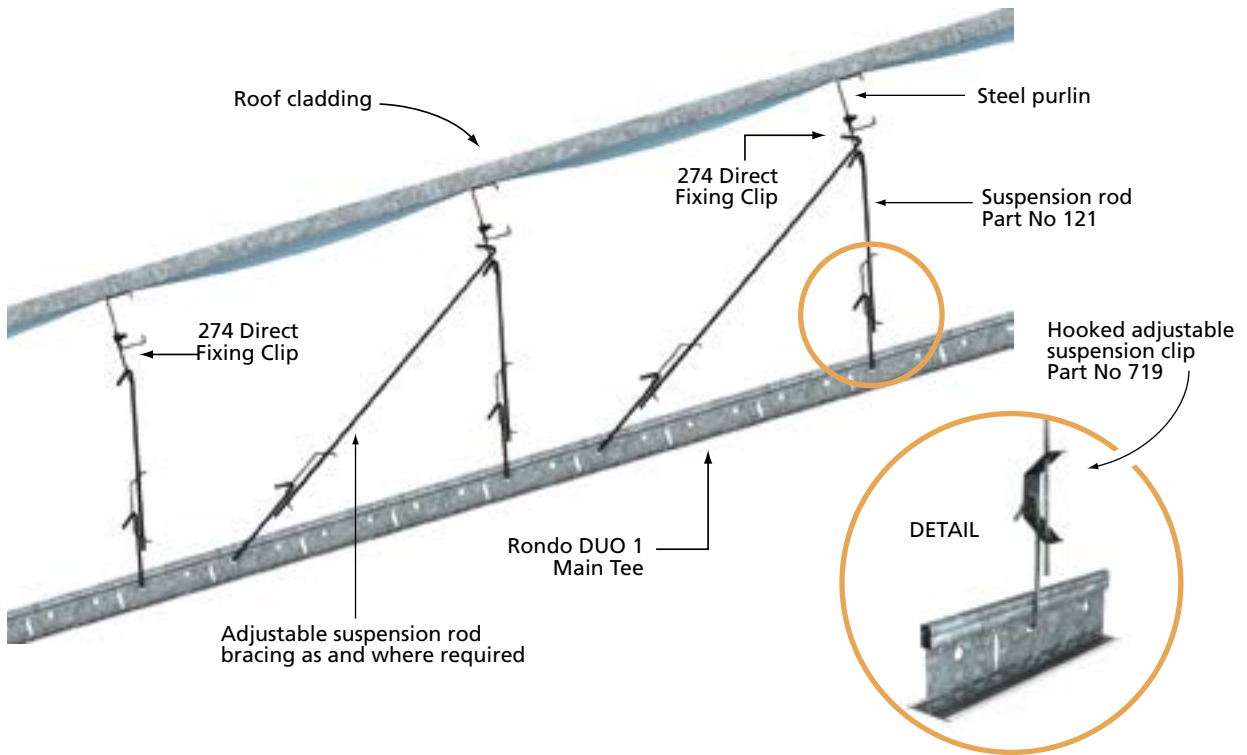

■ SUGGESTED RAKING CEILING DETAIL (maximum pitch: 45°)

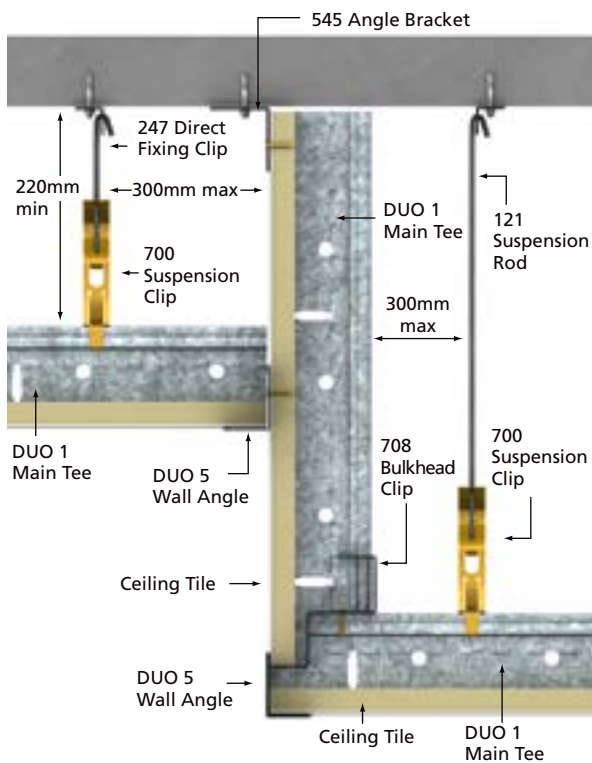

■ SQUARELINE BULKHEAD DETAIL (Vertical Exposed Grid)

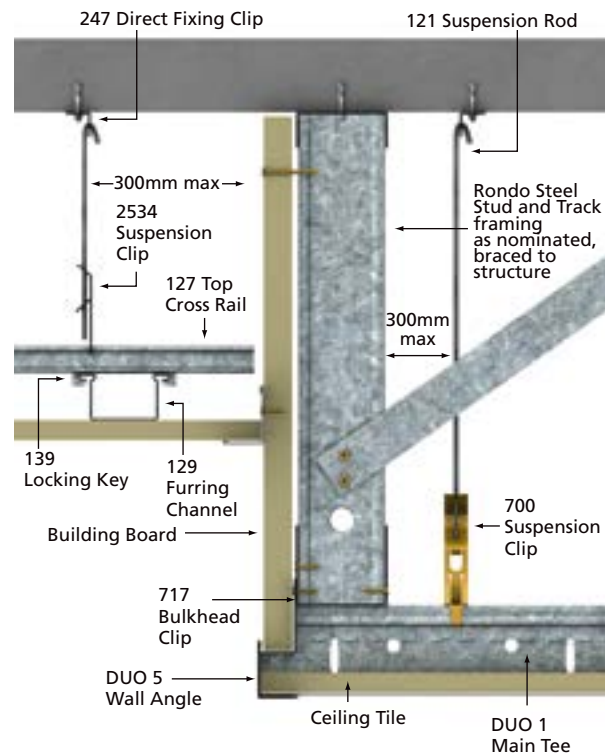

■ SQUARELINE BULKHEAD DETAIL (Vertical KEY-LOCK®/Steel Stud System)

TYPICAL APPLICATION DETAILS (continued)

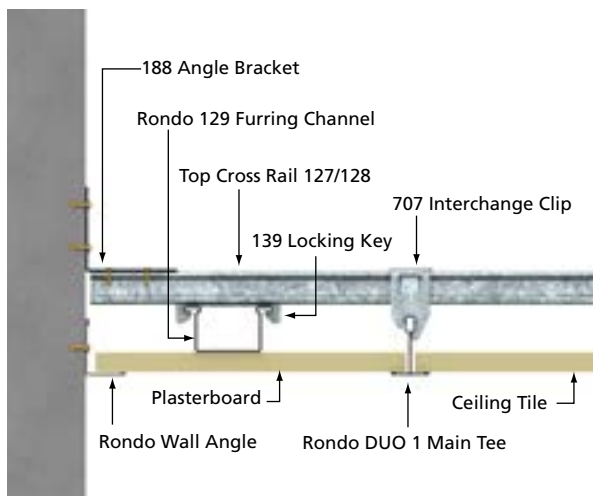

■ ALTERNATIVE PERIMETER DETAIL

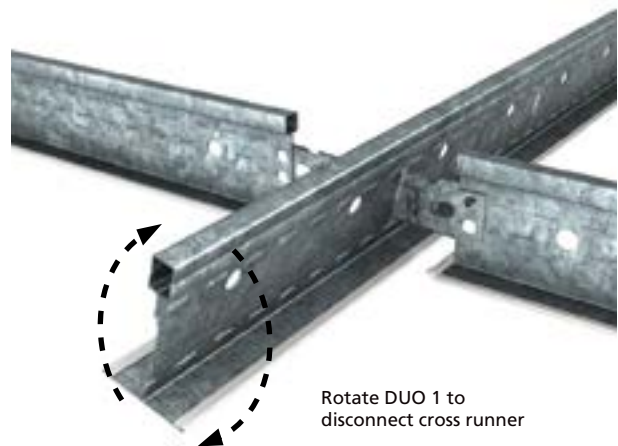

■ CROSS TEE REMOVAL

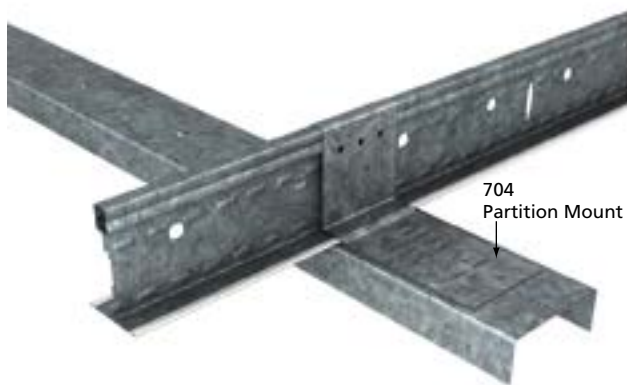

■ PARTITION MOUNTING DETAILS

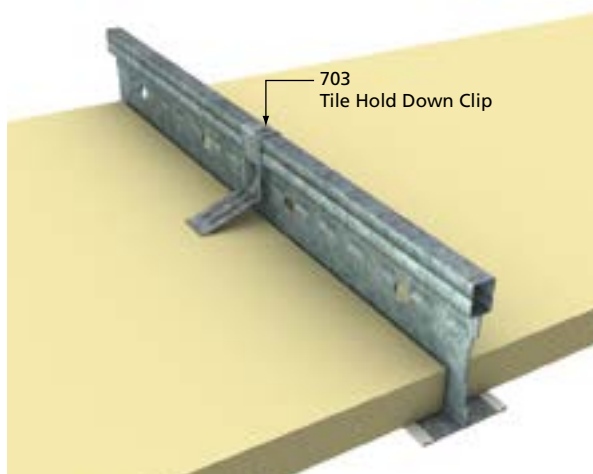
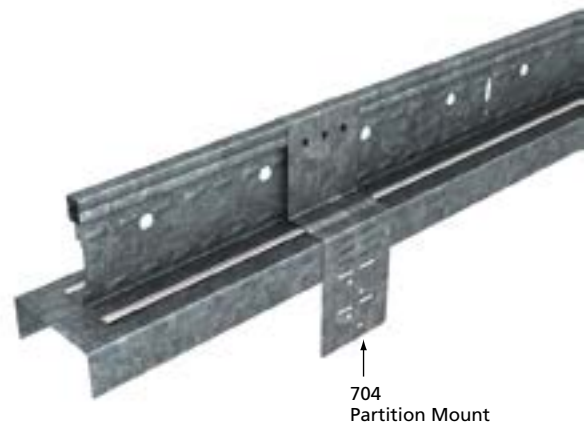

■ TILE HOLDDOWN CLIP

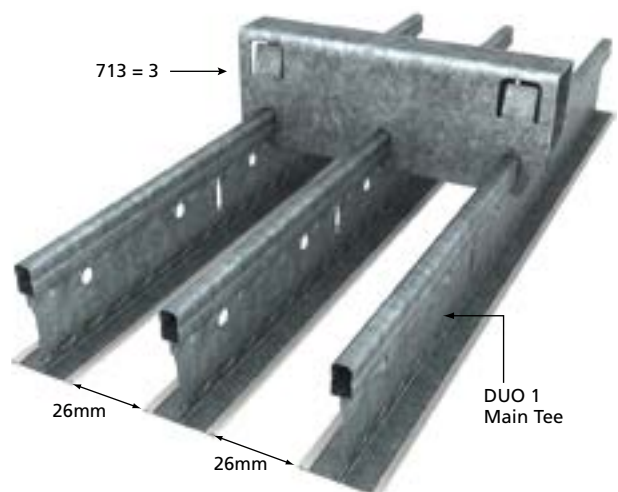

■ AIR DIFFUSER DETAIL

INSTALLATION DETAILS

Two-way Exposed Grid System

STEP ONE

The room must be checked on site to determine if it is out of square. Using the 3/4/5 method (*Figure 1*) will assist in squaring up the room before installation.

Layout ceiling grid module to datum shown on architects drawing, or give equal cut tiles at perimeter walls (*refer Figure 1*).

Work out an even margin along the sides and at both ends.

EXAMPLE (*refer Figure 2*):

Main Tee

4m divided by tile length (1.2m) = 3.3 tile modules.

4m less 3.6m (i.e. 3 full tile lengths) = 400mm.

400mm plus one tile length (1.2m) = 1.6m.

Divide 1.6m by 2 = 800mm margin along each side.

Cross Tee:

5m divided by tile width (600mm) = 8.3 tile modules.

5m less 4.8m (i.e. 8 full tile widths) = 200mm.

200mm plus one full tile width (600mm) = 800mm.

Divide 800mm by 2 = 400mm margin at each side

STEP TWO

Mark each wall to the correct height of the ceiling.

Cut the Perimeter wall angle trim to length, and fix to wall with suitable fasteners at 600mm maximum centres. (*Refer Figure 3.*)

The Wall Angle should be mitred at corner intersections and supported at all joints by appropriate joiners. This will provide a more secure and aesthetic appearance.

(*Refer Figure 4.*)

NOTE:

The perimeter wall angle fixings shall be made to the framing members only, not to the wall linings.

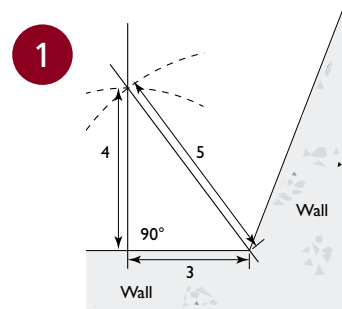

■ USING THE 3/4/5 METHOD TO SQUARE UP A ROOM

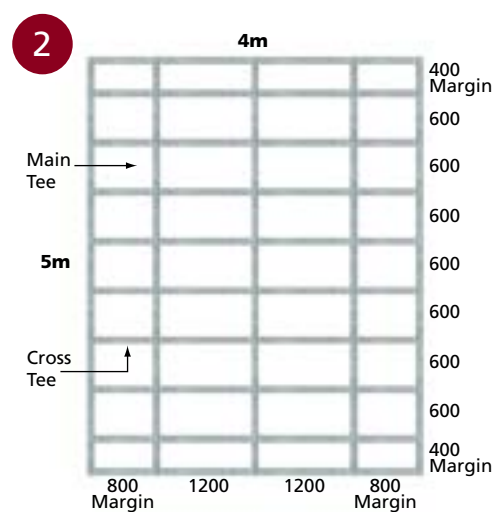

■ WORKING OUT EVEN MARGINS (as per example shown)

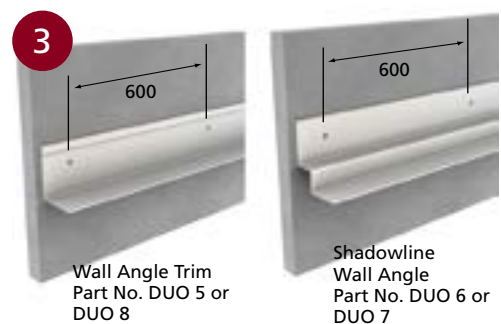

■ PERIMETER WALL ANGLE TRIM

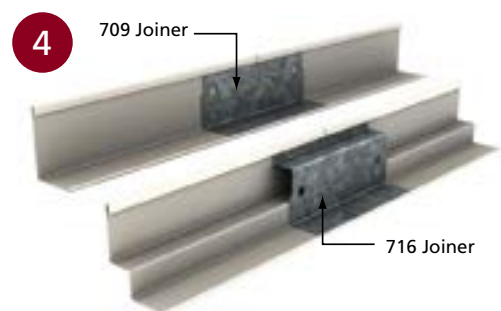

■ WALL ANGLE JOINERS FOR STEEL AND ALUMINIUM

INSTALLATION DETAILS (continued)

Two-way Exposed Grid System (continued)

STEP THREE

Install the Main Tee suspension hanger brackets to the supporting structure to match the spacing of the Main Tees and such that the Main Tee span does not exceed 1200mm.

NOTE:

Ensure the hanger points are set out so that hangers adjacent to the perimeter walls are no more than 300mm from the wall unless otherwise specified.

STEP FOUR

Assemble the suspension clips on suspension rods cut to pre-determined lengths. For the 274 or 247 suspension brackets, bend a hook on one end to 30° as shown (refer Figure 5).

Install all rods or Main Tees into the suspension brackets previously installed, as appropriate (refer Figure 6). If using tie-wire, ensure wire has at least three tight turns (refer Figure 5).

STEP FIVE

Cut Main Tee to length so that the first pre-punched Cross Tee slot is on module as determined in Step One.

5

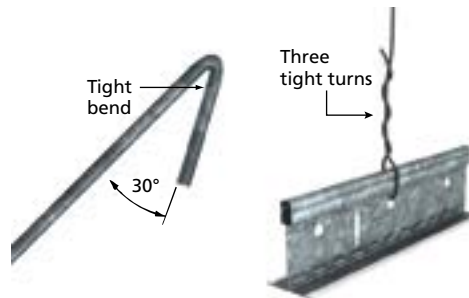

■ SUSPENSION CLIP SHOWING IDEAL BEND AND TIE-WIRE DETAIL

6

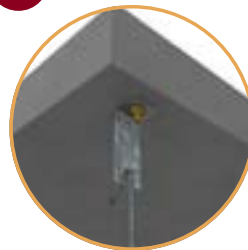

Suspension rod angle bracket Part No 247



Suspension rod bracket Part No 547



Suspension rod bracket Part No 274

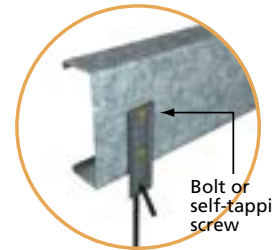

Suspension rod bracket Part No 534



Direct fixing clip Part No 702



■ SUSPENSION ROD BRACKETS

STEP SIX

Install the Main Tee into the Suspension Clips (refer Figures 5 & 7).

The self locking joiners are then pushed together to lock the Main Tees, leaving a hairline connection as detailed (refer Figure 9).

The cut end is held in position using the stabiliser clips. (Refer Figure 8. If using tie-wire, refer Step Four and Figure 5.)

NOTE:

Stagger the Main Tee joints throughout the ceiling.

Keep suspension points within 5° of vertical when using suspension clips 700 & 701 (refer Figure 8).

STEP SEVEN

With a gentle push, install the Cross Tees at the module centres through pre-punched slots in the Main Tees.

Ensure positive locking of both Cross Tee end tags into each other (refer Figure 9).

STEP EIGHT

Level and align the ceiling grid prior to installing the ceiling tiles.

The suspension points can be adjusted to either a string line or laser.

STEP NINE

In large areas to assist in stabilising the grid system, Rondo 705 or 706 Stabiliser Clip should be attached to the perimeter trim at every second or third Main and Cross Tee.

The clips are to be fixed in place with pop rivets or wafer-head self-drilling screws.

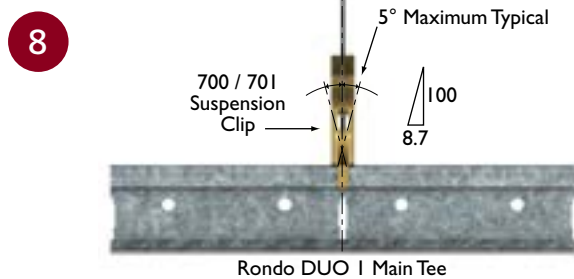

■ INSTALLING THE MAIN TEE INTO SUSPENSION CLIPS



■ STABILISER CLIPS

INSTALLATION DETAILS (continued)

Two-way Exposed Grid System (continued)

STEP TEN

The grid should now be ready for the light fittings to be installed and supported on the Main Tee only.

Air conditioning grilles and ceiling tiles can also be installed. Additional suspension points must be used where specified to carry light fittings or ceiling attachments. (Refer Figure 11 and maximum allowable loads on Page 54.)

600 X 600 GRID MODULES

Install the ceiling grid as described in the previous installation details for a 1200 x 600mm grid module.

Space the Main Tee at 1200mm centres, and 1200mm long Cross Tees at 600mm centres, with additional 600mm long Cross Tee locked in between the 1200mm long Cross Tee to form a 600 x 600mm grid. (Refer Grid Type D on Page 53.)

SPANS GREATER THAN 1200mm

If the span to support the Main Tee is more than 1200mm, the suspension may be inclined using either tie wire or the 719 hooked clips. The angle of suspension should not exceed 15° without further checking by Rondo (refer Figure 12).

NOTE: For alternative grid modules, refer to the Grid Selection Guide on page 54.

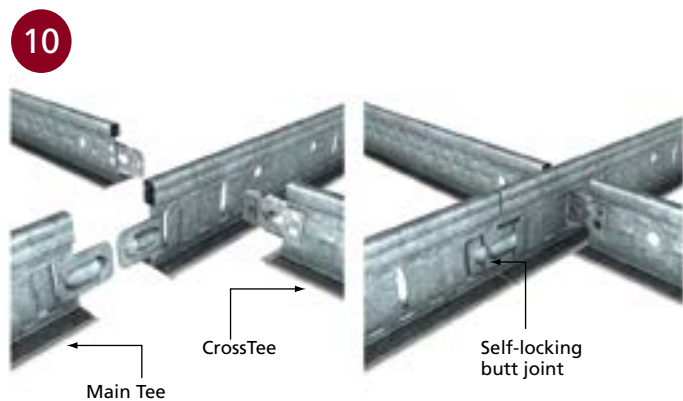

■ TEE JOINTING DETAILS

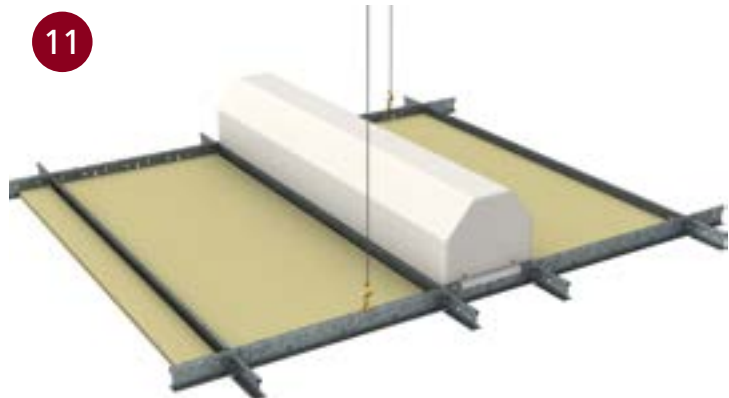

■ LIGHT FITTING DETAIL (WITH ADDITIONAL HANGERS IF REQUIRED)

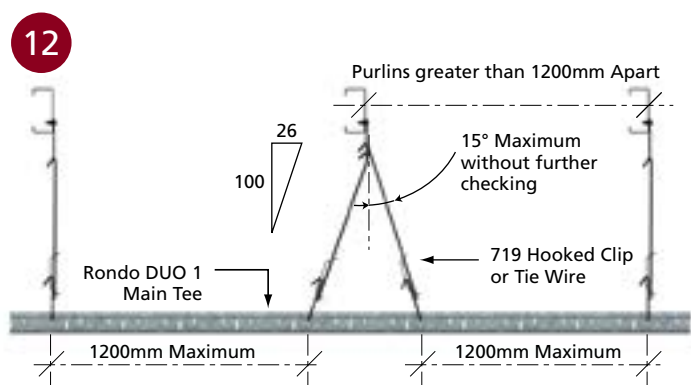

■ SPANS GREATER THAN 1200MM

Exposed Grid Bulkhead System

The Rondo Square Line Bulkhead System allows for easy, economical and true bulkhead corner finishes to be achieved by using concealed support clips and fixings.

STEP ONE

Prepare the ends of the horizontal framing members as shown (refer Figure 13).

STEP TWO

Position Support Clips 708 on the ends of the Main Tees ensuring that the heads are central to the head cut-outs for the vertical members (refer Figure 14).

Drill through the clip into the head and pop rivet.

STEP THREE

Introduce the Bulkhead Trim DUO 5 to the support clips (refer Figure 15).

STEP FOUR

Join Bulkhead Trim end to end using Joiner 709 to give a flush finish. (refer Figure 16).

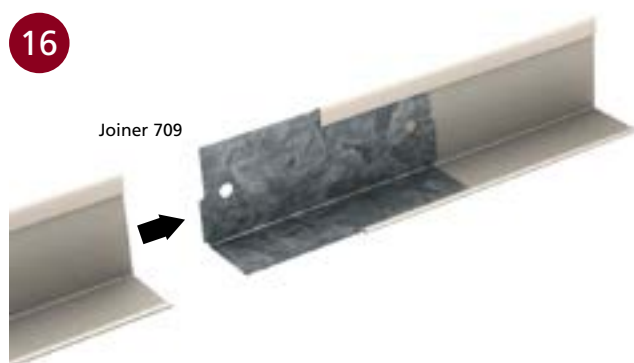

■ BULKHEAD JOINER DETAILS

STEP FIVE

Prepare the ends of the vertical members as shown, and introduce into the profiled cut-outs in the Support Clips (refer Figures 17 & 18).

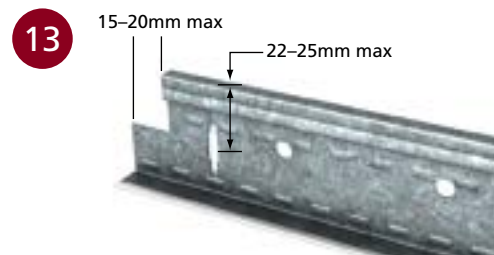

■ HORIZONTAL FRAMING MEMBERS

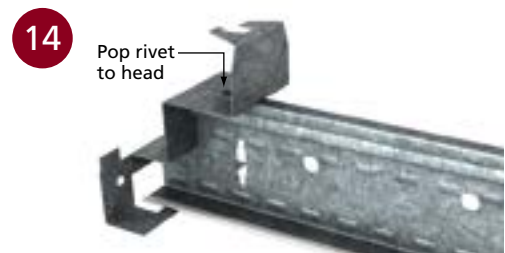

■ SUPPORT CLIPS



■ INTRODUCING TRIM TO THE SUPPORT CLIPS

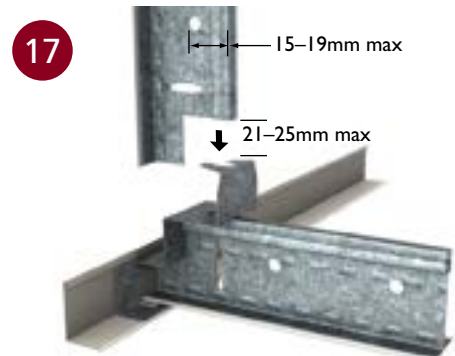

■ VERTICAL MEMBERS

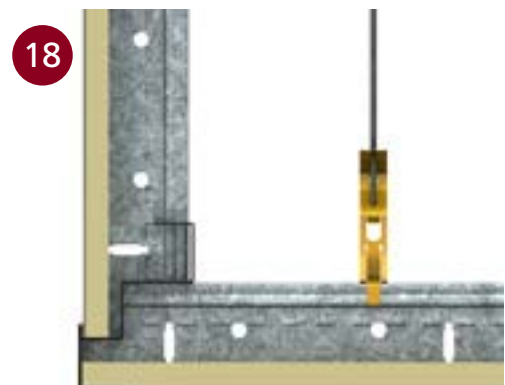

■ BULKHEAD SYSTEM DETAIL

INSTALLATION DETAILS (continued)

Concealed Vertical Bulkhead System

STEP ONE

Install the metal framework using Rondo Steel Studs and Tracks and braced to engineer's specifications.

STEP TWO

Attach Support Clips 717 to the framework so as to line up with the plane of the exposed grid (refer Figure 19).

STEP THREE

Introduce the DUO 5 Bulkhead Trim to the Support Clips (refer Figure 20).

STEP FOUR

Join the Bulkhead Trim end to end using Joiners 709 to give a flush finish. Join the Bulkhead Trim at the corners using Internal Corner Joiner 711 and External Corner Joiner 710 (refer Figure 16 on Page 49).

STEP FIVE

Introduce the vertical building board and screw-fix to the framework (refer Figure 21).

STEP SIX

Assemble and install the exposed grid, with the ends of the framing members prepared to fit into the Support Clips as shown.

Provide suspension to the Main Tees within 300mm of the bulkhead framing (refer Figure 22).

STEP SEVEN

Install ceiling panels (refer Figure 23).

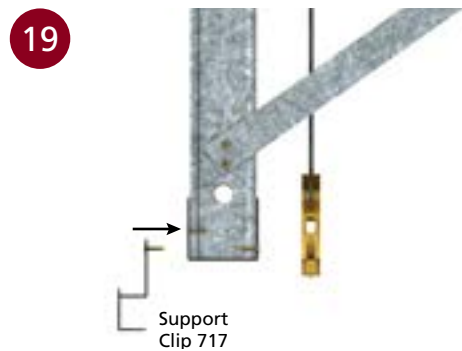

■ SUPPORT CLIPS

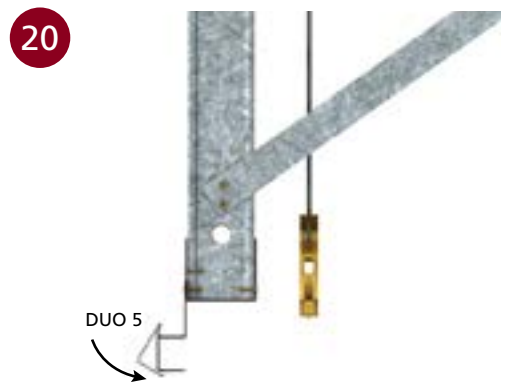

■ BULKHEAD TRIMS



■ ASSEMBLY OF GRID



■ VERTICAL SCREW-FIX SYSTEM DETAIL

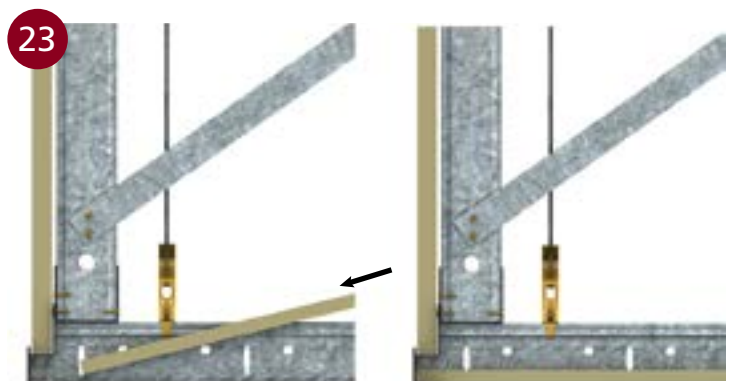

■ CEILING PANEL INSTALLATION

PRODUCT DATA SPECIFICATIONS

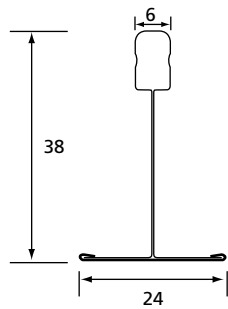

Rondo DUO 1
24mm MAIN TEE

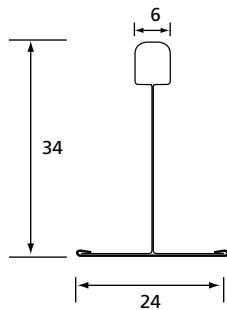

Rondo DUO 2/DUO H
24mm CROSS TEE

MATERIAL SPECIFICATIONS

The Rondo DUO 2 Cross Tee base section is double-web cold rollformed from hot-dipped, zinc-coated galvanised steel strip. Rondo DUO 1 and DUO H sections are hot-dipped steel with a zinc or zinc-aluminium alloy coating.

The exposed capping face is cold rollformed onto the base section from hot-dipped, zinc-coated galvanised steel strip with a factory-applied polyester paint finish.

MASS

MAIN TEE

24 x 38mm DUO 1: 0.30kg per lineal metre.

CROSS TEE

24 x 34mm DUO 2: 0.24kg per lineal metre.

24 x 34mm DUO H: 0.30kg per lineal metre.

ADDITIONAL LOADS

The suspension system is designed to carry the weight of the ceiling only. Additional loads are not to be placed upon or carried by the suspension system without prior reference to Rondo Technical Services.

NOTE:

See page 54 for the maximum load tables for each module design.

TABLE 1: SECTION DIMENSIONS

RONDO PART NO	AREA mm ²	T (BMT) mm	Xc mm	Yc mm	SELF-WEIGHT kg/m
DUO 1 24mm MAIN TEE	31.7	0.30	11.8	21.4	0.30
DUO 2 24mm CROSS TEE	24.4	0.25	11.9	19.3	0.24
DUO H 24mm CROSS TEE	27.6	0.30	12.0	14.48	0.30

PRODUCT DATA SPECIFICATIONS (continued)

Colour Matching

If wishing to colour match light fittings or air registers etc to the Rondo DUO® Exposed Grid Ceiling System, we recommend that items be powder coated using Interpon MA 289 Cool White powder.

As powder coating compounds can vary from batch to batch, Rondo is not responsible for the ultimate colour match and recommends that a sample piece of Rondo DUO® Exposed Grid Ceiling System from the project be provided to the powder coater to assist his colour matching process.

This is particularly important as there can be slight variations in the colour of batches of the pre-painted capping Rondo rolls its grid components, including its colour matched perimeter trims.

It should further be recognised that there is often a difference in colour rendition when applying paint to different base materials.

IMPORTANT THINGS TO KNOW:

- When cutting ceiling grid to finish at the perimeter trim, it is recommended that a gap of no more than 5mm between the inside of the trim and the end of the grid component is allowed for movement, whether or not stabiliser clips are being used.
- The Rondo DUO 8 long leg aluminium perimeter angle trim should be used when finishing a ceiling to a concrete "Tilt-Up" wall construction. The trim should be fixed through the 19mm leg so that the grid is resting on the 32mm leg, and therefore provides a wider landing surface to counter the effects of thermal movement. The Rondo 705 stabiliser clip can be used with this trim no matter which way around it is fixed.
- **Curved Walls & Columns:** Rondo is able to provide radiussed aluminium shadowline and angle wall trims as well as column trims. There are limitations to the radii achievable and reference should be made to your Rondo Technical representative or Authorised Rondo Distributor for further information if uncertain.
- Rondo manufacture and supply all components ready for use. There should be no requirement to manipulate the products unless specifically designed otherwise. Should you find the components do not readily assemble as detailed, please contact your local Rondo representative before proceeding.

STANDARD GRIDS

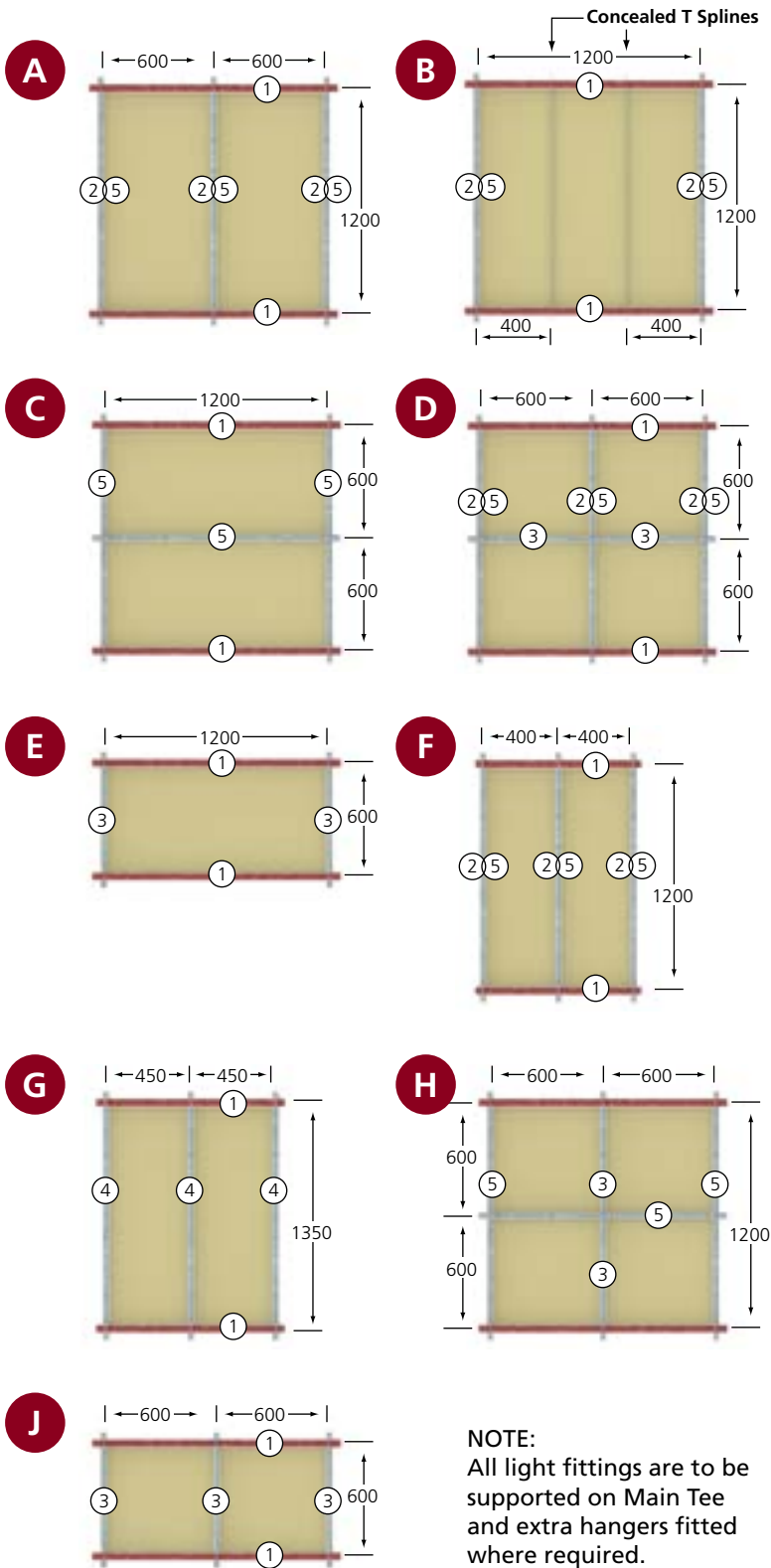

KEY

 Indicates Main tee

 Indicates alternative: either 2 or 5

NOTE:
All light fittings are to be supported on Main Tee and extra hangers fitted where required.
Main Tee suspension is 1200mm along its length. Refer to Rondo for further information regarding suspension at other centres.

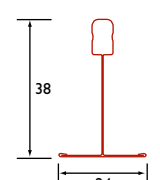
MAIN TEE	REF	PART NO	LENGTH
	1	DUO 1	3600

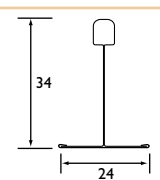
CROSS TEE	REF	PART NO	LENGTH
	2	DUO 2	1200
	3	DUO 2	600
	4	DUO H	1350
	5	DUO H	1200

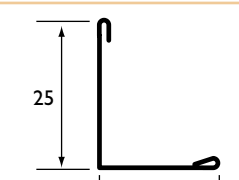
STEEL WALL ANGLE	PART NO	LENGTH
	DUO 5	3600

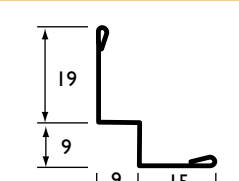
STEEL SHADOWLINE	PART NO	LENGTH
	DUO 6	3600

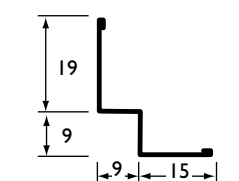
ALUMINIUM SHADOWLINE	PART NO	LENGTH
	DUO 7	3600

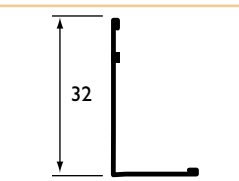
ALUMINIUM WALL ANGLE	PART NO	LENGTH
	DUO 8	3600

GRID SELECTION GUIDE

TABLE 3: TEE SPACING/MAX. ALLOWABLE LOADS

SYSTEM		FACE SIZE mm	SPACING OF M/TS mm	SPACING OF X/TS mm	ALLOWABLE LOAD kg/m ²
A	DUO 1-H	24	1200	600	14.2
	DUO 1-2	24	1200	600	12.4
B	DUO 1-H	24	1200	1200	19.8
	DUO 1-2	24	1200	1200	19.8
C	DUO 1-H	24	1200	600	8.4
D	DUO 1-H	24	1200	600	14.2
	DUO 1-2	24	1200	600	12.4
E	DUO 1-2	24	600	1200	26.0
F	DUO 1-H	24	1200	400	19.8
	DUO 1-2	24	1200	400	19.8
G	DUO 1-H	24	1350	450	11.4
H	DUO 1-H	24	1200	1200	8.4
J	DUO 1-2	24	600	600	26.0

NOTE:

Allowable loads are based on suspension points at 1200 centres along the Main Tee.

All light fittings are to be supported on Main Tees with additional hangers fitted, as required.

All maximum allowable load values stated assume the Main Tees are continuously spanned over three (3) or more suspension points.

IMPORTANT FIXING INFORMATION

Suspending Ceilings from Purlins

Rondo does not produce a suspension clip for attachment to the lip of steel purlins ('C' or 'Z' purlins, etc.) for the following reasons:

AS/NZS 2785:2000 Suspended Ceilings – Design and Installation details the following in respect to this issue:

- Section 4 Installation – Part 4.4: “In the case of purlins, the top fixing shall be made to the web of the purlin unless specifically designed otherwise”
- APPENDIX G Fixing (Informative): G2 Top Fixing, G2.1 Purlin Fixings:
“Purlin fixings should be as follows:
A) Connections should be made to the web of the purlin, unless specifically designed otherwise
B) Where flange connections are necessary, they should be made as close as possible to the web of the purlin
C) Purlin manufacturers do not recommend attaching the top fixing to the lip of the purlin
D) Fixings should be selected and installed in accordance with the manufacturers specifications.”

RONDO ALUMINIUM COMPONENTS

The Rondo Aluminium Ceiling System is an alternative to the Rondo DUO Exposed Grid Ceiling System. Unlike the DUO system, the Aluminium Main Tee to Cross Tee intersection is a butt joint which provides a flat, ghost free surface into which the ceiling panel fits.

The Cross tees have integrated locking tags enabling them to snap together positively at intersections whilst the Main Tee has a separate splicing plate to join lengths of the Main Tee together.

PRIMARY SECTIONS

357	24mm Face x 38mm Aluminium Cross Tee
359	24mm Face x 38mm Aluminium Lightweight Main Tee

PRIMARY SECTIONS



PRIMARY SECTION JOINER



PRIMARY SECTION JOINER

358	359 Main Tee Joiner
-----	---------------------

WALL ANGLES

DUO 7	Shadowline Wall Angle: Aluminium 19 x 9 x 9 x 15mm
DUO 8	Aluminium Wall Angle: 32 x 19mm

WALL ANGLES



BULKHEAD TRIM

321	Aluminium Direct Fix – 13mm PB
-----	--------------------------------

BULKHEAD TRIM



PRIMARY SUSPENSION CLIP



PRIMARY SUSPENSION CLIP

356	Spring Adjusted to suit 359
-----	-----------------------------

SUSPENSION ROD BRACKETS

247	Suspension rod Angle Bracket
274	Suspension rod bracket
534	Suspension rod bracket: Timber – Steel
547	Suspension rod bracket: Concrete

SUSPENSION ROD BRACKETS



SUSPENSION ROD

121	5mm Soft Gal. Susp. Rod
-----	-------------------------

SUSPENSION ROD



ANGLE BRACKET



ANGLE BRACKET

188	Angle Bracket
-----	---------------

TOUCH-UP PAINT

772	For steel and aluminium grid (150g can)
-----	---

TOUCH-UP PAINT



ACCESSORIES

ACCESSORIES

705	Stabiliser Clip DUO5/DUO8 – Main Tee/Cross Tee
706	Stabiliser Clip DUO6 /DUO7– Main Tee/Cross Tee



TYPICAL APPLICATION & INSTALLATION DETAILS

The typical application and installation details for Rondo's Aluminium Ceiling System are the same as for Rondo's DUO Exposed Grid Ceiling System, **except for the following differences:**

356 SUSPENSION CLIP

The 356 Suspension Clip slips over the upstand of the 359 Main Tee so that its locating lug 'clicks' into the pre-drilled hole in the tee section. The ceiling is leveled by squeezing the prongs of the clip together and sliding the assembly up or down the suspension rod until the required level is achieved then releasing the clip (see Figure 1).

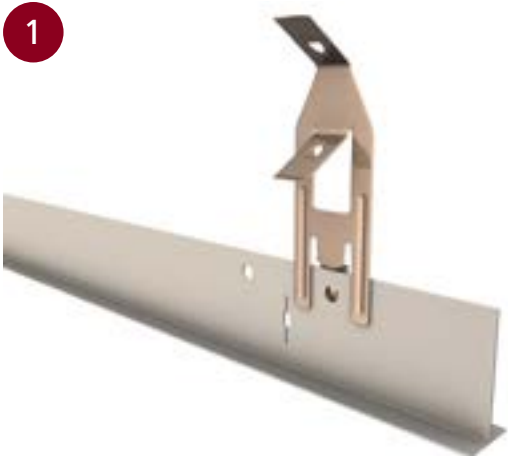

■ 356 CLIP AND 359 MAIN TEE

JOINING 357 AND 359 TEES

When the Main 359 and Cross 357 Tees are joined, the sections 'butt' together forming a smooth 'ghost' free intersection (see Figure 2).



■ 357 & 359 TEES JOINED

TYPICAL APPLICATION & INSTALLATION DETAILS (continued)

358 JOINER PLATE

The 359 Main Tees are joined by the 358 Joiner Plate and secured to form a tight junction by bending the tabs closed once positioned through the pre-formed slots in the Main Tee (see Figures 3 & 4).

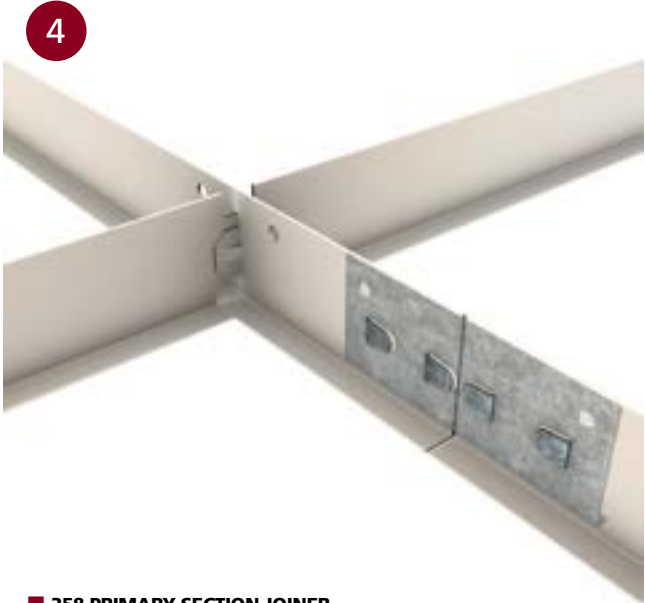

■ 358 PRIMARY SECTION JOINER

DUO7 & DUO 8

The same aluminium perimeter trims used with the DUO® system are colour matched to this aluminium system.

Both the DUO7 Shadowline and DUO8 Angle can be used with DUO Perimeter Trim Stabiliser Clips, Rondo 705 (for DUO8) and 706 (for DUO7) (see Figures 5 & 6)

The standard perimeter finish is to rest the abutting tee sections onto the perimeter trim. "Cutting" the tee sections into the perimeter trim is an impractical exercise as movement in the ceiling or the perimeter walls will result in unsightly gaps between grid and trim at perimeters.



188 ANGLE BRACKET

If for any reason, such as bulkhead trimming, it is necessary to join the grid and trim permanently the 188 Angle Bracket can be used with self tapping screws or pop rivets through its pre-drilled holes.



321 BULKHEAD TRIM

The 321 pre-finished aluminium bulkhead trim provides a matching element between plasterboard bulkheads and the aluminium grid ceiling.

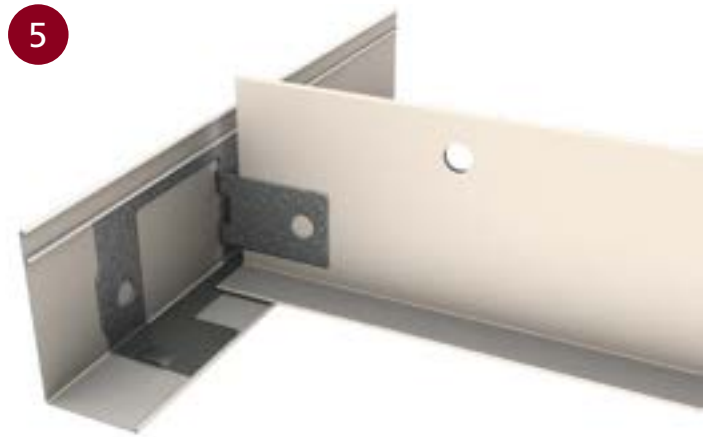

■ DUO8 WITH 705 CLIP

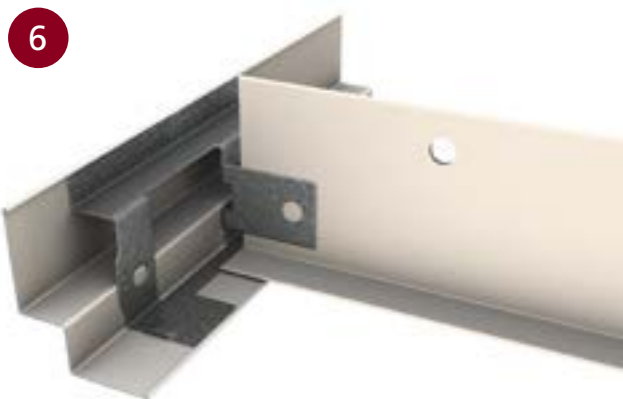

■ DUO7 WITH 706 CLIP

ALUMINIUM STANDARD GRIDS

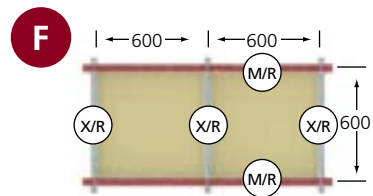
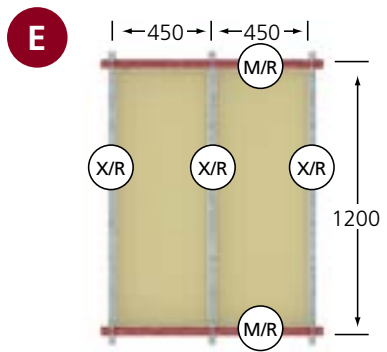
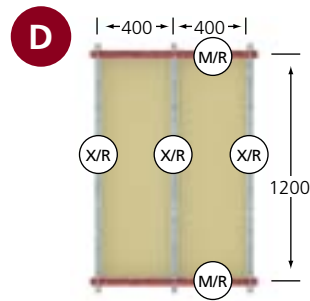
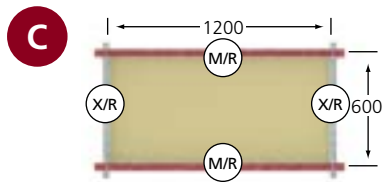
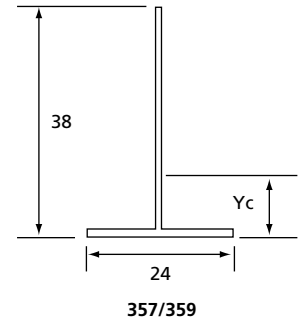
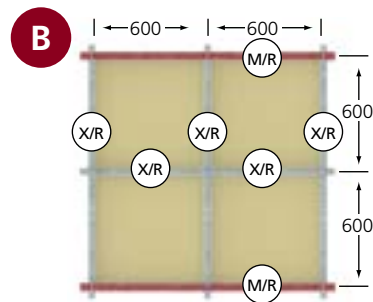
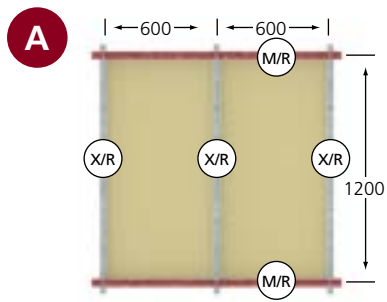

TABLE 4: SECTION DIMENSIONS

RONDO PART NO	D mm	AREA mm ²	Xc mm	Yc mm	WEIGHT kg/m
357/359	38.10	75.47	12.0	12.16	0.204

ALUMINIUM GRID SELECTION GUIDE

TABLE 5: TEE SPACING/MAX. ALLOWABLE LOADS

SYSTEM	M/R SPAN mm	M/R TYPE	X/R TYPE	ALLOWABLE LOAD kg/m ²
A	1200	359	357	7.0
B	1200	359	357	7.2
C	1200	359	357	10.4
D	1200	359	357	10.1
E	1200	359	357	9.5
F	1200	359	357	10.4

NOTE:
 Allowable loads are based on suspension points at 1200mm centres along the Main Tee.
 All light fittings are to be supported on Main Tees with additional hangers fitted, as required.
 All maximum allowable load values stated assume the Main Tees are continuously spanned over three (3) or more suspension points.