

Construction of buildings in bushfire prone areas to AS 3959 2009

Important

This technical supplement must be read in conjunction with the current technical product literature. James Hardie building products must be installed in accordance with the applicable technical product literature. All components and accessories must be installed in accordance with the respective manufacturer's specifications. For the product warranty, terms and conditions refer to the applicable James Hardie technical product literature.

Scope

The new Building Code of Australia (BCA) was introduced in 2011 and adopts the updated AS 3959:2009 that covers 'Construction of buildings in bushfire prone areas'. These new bushfire requirements have been adopted by all states with variations in New South Wales and Tasmania.

These state variations are outlined below:

New South Wales:

For a Class 1 or class 10a building or deck associated with a Class 1 building it must be constructed in accordance with the following:

- AS 3959, except for Section 9 Construction for Bushfire Attack Level FZ (BAL-FZ). Buildings subject to BAL-FZ must comply with specific conditions of development consent for construction at this level; or
- the requirements of (a) above as modified by the development consent following consultation with the NSW Rural Fire Service under section 79BA of the Environmental Planning and Assessment Act 1979; or
- the requirements of (a) above as modified by development consent with a bushfire safety authority issued under section 100B of the Rural Fires Act 1997 for the purposes of integrated development.

Tasmania:

Tasmania has adopted the new AS 3959 but has additional requirements for vehicle access and water supply. Refer to the BCA for more information

Uses

This technical supplement is intended to be used as a guide in the design and construction of buildings in bushfire-prone areas in accordance to Australian Standard 3959-2009 'Construction of buildings in bushfire prone areas.'

This supplement promotes the successful use of non-combustible James Hardie® building materials. This technical supplement does not cover all areas of bushfire construction including but not limited to doors, windows, fascias, roofs, penetrations etc. Refer to the standard for other building components.

This supplement does not replace the standard but helps educate designers and builders on improving the performance of buildings when subjected to bushfire prone areas.

This supplement must be read in conjunction with the current Australian Standard and local building regulations.

Overview

AS 3959-2009 specifies requirements for the construction of buildings in bushfire prone areas in order to improve their resistance to bushfire attack from:

- Burning embers
- Flame contact
- Radiant heat
- Combinations of the three attack forms

There are six bushfire attack levels, AS3959-2009 contains construction solutions for all BAL's. Construction requirements increase as BAL levels increase.

BAL levels:

BAL - LOW, BAL - 12.5, BAL - 19, BAL - 29, BAL - 40, BAL - FZ

NOTE

The number after the BAL is based on heat flux exposure thresholds in kW/m².

Where sarking is required, it shall have a flammability index of not more than 5 when tested to AS1530.2

The following table outlines James Hardie external cladding product suitability and additional requirements to adhere to BAL construction requirements.

TABLE 1

EXTERNAL CLADDING	BAL Rating				
	12.5	19	29	40	FZ
Scyon™ Matrix™ cladding	✓	✓	✓	✓*	✓*
Scyon™ Axon™ cladding	✓	✓	✓	✓	✓*
Scyon™ Stria™ cladding	✓	✓	✓	✓	✓*
Scyon™ Linea™ weatherboard	✓	✓	✓	✓	✓*
HardieFlex™ sheets 6mm	✓	✓	✓	✓*	✓*
PrimeLine® weatherboard	✓	✓	✓	✓	✓*
HardiePlank™ weatherboard	✓	✓	✓	✓*	✓*
PanelClad™ sheets	✓	✓	✓	✓*	✓*
EasyLap™ panels	✓	✓	✓	✓	✓*
HardieTex™ base sheets	✓	✓	✓	✓*	✓*
Comtex™ facade panel and fixing system	✓	✓	✓	✓	✓*
ExoTec™ facade panel and fixing system	✓	✓	✓	✓	✓*
DECKING	12.5	19	29	40	FZ
HardieDeck™ system	✓	✓	✓	✓	✓

* HardieSmart™ Boundary Wall System is required. Refer to figure 3 for more information or alternatively download HardieSmart Boundary Wall Design Guide available at www.Jameshardie.com.au or www.accel.com.au

The following table outlines solutions to internal floor, decking and external walls using James Hardie® products. However, the following table must be read in conjunction with the current code.

BUILDING IN BUSHFIRE-PRONE AREAS IN ACCORDNACE WITH AS 3959: 2009 – RELATED TO FIBRE CEMENT IN FLOOR AND EXTERNAL WALLS ONLY		
Building Element	Australian Standard 3959: 2009 Requirement	James Hardie Recommendations
CONSTRUCTION FOR BUSHFIRE ATTACK LEVEL BAL's 12.5 AND 19		
FLOORS	<p>FLOORS</p> <p>Concrete slabs on ground This Standard does not provide construction requirements for concrete slabs on the ground.</p> <p>Elevated floors This Standard does not provide construction requirements for elevated floors, including bearers, joists and flooring.</p> <p>Decking - Floor This Standard does not provide construction requirements for decking that is more than 300 mm from a glazed element.</p> <p>Decking less than 300 mm (measured horizontally at deck level) from glazed elements that are less than 400 mm (measured vertically) from the surface of the deck (see Figure D2, Appendix D) shall be made from:</p> <p>(a) non-combustible material; or (b) bushfire-resisting timber (see Appendix F); or (c) a timber species, as specified in Paragraph E1 and listed in Table E1 of Appendix E;</p> <p>For BAL 12.5 (d) PVC-U (e) a combination of any of Items (a), (b), (c) or (d) above.</p> <p>For BAL 19 (d) a combination of any of Items (a), (b) or (c) above.</p>	<p>All James Hardie flooring products are deemed non-combustible in accordance with BCA section C1.9.</p> <p>James Hardie flooring products include:</p> <ul style="list-style-type: none"> ■ Scyon™ Secura™ interior flooring ■ Scyon™ Secura™ Exterior flooring ■ HardiePanel™ compressed sheets ■ HardieDeck™
EXTERNAL WALLS	<p>EXTERNAL WALLS</p> <p>Walls That part of an external wall surface that is less than 400 mm from the ground or less than 400 mm above decks, carport roofs, awnings and similar elements or fittings having an angle less than 18 degrees to the horizontal and extending more than 110 mm in width from the wall (see Figure D3, Appendix D) shall be of:</p> <p>(a) non-combustible material; or (b) fibre-cement external cladding, a minimum of 6 mm in thickness; or (c) bushfire-resisting timber (see Appendix F); or (d) a timber species as specified in Paragraph E1 and listed in Table E1, Appendix E; or (e) a combination of any of Items (a), (b), (c) or (d) above.</p> <p>For BAL 12.5 There are no requirements for external wall surfaces 400 mm or more from the ground or for external wall surfaces 400 mm or more above decks, carport roofs, awnings and similar elements or fittings having an angle less than 18 degrees to the horizontal and extending more than 110 mm in width from the wall (see Figure D3, Appendix D).</p> <p>For BAL 19 This Standard does not provide construction requirements for external wall surfaces 400 mm or more from the ground or for external wall surfaces 400 mm or more above decks, carport roofs, awnings and similar elements or fittings having an angle less than 18 degrees to the horizontal and extending more than 110 mm in width from the wall (see Figure D3, Appendix D).</p> <p>Joints All joints in the external surface material of walls shall be covered, sealed, overlapped, backed or butt-jointed to prevent gaps greater than 3 mm.</p> <p>Alternatively, sarking-type material may be applied over the outer face of the frame prior to fixing any external cladding.</p> <p>Vents and Weepholes Vents and weepholes in external walls shall be screened with a mesh with a maximum aperture of 2 mm, made of corrosion-resistant steel, bronze or aluminum, except where the vents and weepholes are less than 3 mm (see Clause 3.6), or are located in an external wall of a subfloor space.</p>	<p>All James Hardie external cladding products 6mm or greater in thickness, are suitable for external walls.</p> <p>Please refer to table 1 for product suitability.</p> <p>They are deemed as a non combustible material in accordance with C1.9 and part 3.7.1.2 of the Building Code of Australia.</p> <p>They are also deemed a fibre cement external cladding material as they are manufactured in accordance with AS/NZS 2908.2.</p>

BUILDING IN BUSHFIRE-PRONE AREAS IN ACCORDANCE WITH AS 3959: 2009 – RELATED TO FIBRE CEMENT IN FLOOR AND EXTERNAL WALLS ONLY

Building Element	Australian Standard 3959: 2009 Requirement	James Hardie Recommendations
CONSTRUCTION FOR BUSHFIRE ATTACK LEVEL BAL 29		
FLOORS	<p>FLOORS</p> <p>Concrete slabs on ground This Standard does not provide construction requirements for concrete slabs on ground.</p> <p>Elevated floors</p> <p>Enclosed subfloor space This Standard does not provide construction requirements for elevated floors, including bearers, joists and flooring, where the subfloor space is enclosed with:</p> <ul style="list-style-type: none"> (a) a wall that complies with Clause 7.4; or (b) a mesh or perforated sheet with a maximum aperture of 2 mm, made of corrosion resistant steel, bronze or aluminium; or (c) a combination of Items (a) and (b) above. <p>Unenclosed subfloor space Where the subfloor space is unenclosed, flooring material, including bearers, joists and flooring less than 400 mm above finished ground level, shall be:</p> <ul style="list-style-type: none"> (a) non-combustible (e.g., concrete, steel); or (b) of bushfire-resisting timber (see Appendix F); or (c) particleboard or plywood flooring where the underside is lined with sarking-type material or mineral wool insulation; or (d) a system complying with AS 1530.8.1; or (e) a combination of any of Items (a), (b), (c) or (d) above. <p>This Standard does not provide construction requirements for elements of elevated floors, including bearers, joists and flooring, if the underside of the element is 400 mm or more above finished ground level.</p> <p>Decking - Floor Decking shall be:</p> <ul style="list-style-type: none"> (a) of non-combustible material; or (b) of bushfire-resisting timber (see Appendix F); or (c) a combination of Items (a) and (b) above. 	<p>All James Hardie flooring products are deemed non-combustible in accordance with BCA section C1.9.</p> <p>James Hardie flooring products include:</p> <ul style="list-style-type: none"> ■ Scyon™ Secura™ interior flooring ■ Scyon™ Secura™ Exterior flooring ■ HardiePanel™ compressed sheets ■ HardieDeck™
EXTERNAL WALLS	<p>EXTERNAL WALLS</p> <p>Walls Walls shall be one of the following:</p> <ul style="list-style-type: none"> (a) Made of non-combustible material (e.g., full masonry, brick veneer, mud brick, concrete, aerated concrete). or (b) Made of timber-framed or steel-framed walls that are sarked on the outside of the frame and clad with: <ul style="list-style-type: none"> (i) fibre-cement external cladding, a minimum of 6 mm in thickness; or (ii) steel sheet; or (iii) bushfire-resisting timber (see Appendix F); or (iv) a combination of any of Items (i), (ii) or (iii) above. or (c) A combination of Items (a) and (b) above. <p>Joints All joints in the external surface material of walls shall be covered, sealed, overlapped, backed or butt-jointed to prevent gaps greater than 3 mm.</p> <p>Alternatively, sarking-type material can be applied over the frame prior to fixing any external cladding.</p> <p>Vents and weepholes Vents and weepholes in external walls shall be screened with a mesh with a maximum aperture of 2 mm, made of corrosion-resistant steel, bronze or aluminium, except where they are less than 3 mm (see Clause 3.6).</p>	<p>All James Hardie external cladding products 6mm or greater in thickness, are suitable for external walls when installed with HardieWrap™ weather barrier.</p> <p>Please refer to table 1 for product suitability.</p> <p>They are deemed as a non combustible material in accordance with C1.9 and part 3.7.1.2 of the Building Code of Australia.</p> <p>They are also deemed a fibre cement external cladding material as they are manufactured in accordance with AS/NZS 2908.2.</p>

**BUILDING IN BUSHFIRE-PRONE AREAS IN ACCORDANCE WITH AS 3959:
2009 – RELATED TO FIBRE CEMENT IN FLOOR AND EXTERNAL WALLS ONLY**

Building Element	Australian Standard 3959: 2009 Requirement	James Hardie Recommendations
-------------------------	---	-------------------------------------

CONSTRUCTION FOR BUSHFIRE ATTACK LEVEL BAL 40

<p>FLOORS</p>	<p>FLOORS</p> <p>Concrete slabs on ground This Standard does not provide construction requirements for concrete slabs on ground.</p> <p>Elevated floors Enclosed subfloor spaces This Standard does not provide construction requirements for elevated floors, including bearers, joists and flooring, where the subfloor space is enclosed with a wall that complies with Clause 8.4.</p> <p>Unenclosed subfloor spaces Where the subfloor space is unenclosed, the flooring material, including bearers, joists and flooring, shall:</p> <p>(a) be non-combustible (e.g., concrete, steel); or (b) have the underside of the combustible elements of the floor system protected with a non-combustible material (e.g., fibre-cement sheet or metal sheet); or (c) comply with AS 1530.8.1; or (d) be a combination of any of Items (a), (b) or (c) above.</p> <p>Decking Decking shall be:</p> <p>(a) of non-combustible material; or (b) a system complying with AS 1530.8.1, or (c) a combination of Items (a) and (b) above.</p>	<p>All James Hardie flooring products are deemed non-combustible in accordance with BCA section C1.9.</p> <p>James Hardie flooring products include:</p> <ul style="list-style-type: none"> ■ Scyon™ Secura™ interior flooring ■ Scyon™ Secura™ Exterior flooring ■ HardiePanel™ compressed sheets ■ HardieDeck™ <p>NOTE James Hardie 6mm HardieFlex™ sheets may be a suitable non-combustible material to have on the underside of a floor system for an unenclosed subfloor space.</p>
<p>EXTERNAL WALLS</p>	<p>EXTERNAL WALLS</p> <p>Walls Walls shall be one of the following:</p> <p>(a) Walls made from non-combustible material (e.g., full masonry, brick veneer, mud brick, concrete, aerated concrete). or (b) Timber-framed or steel-framed walls that are sarked on the outside of the frame and clad with:</p> <p style="padding-left: 20px;">(i) fibre-cement external cladding, a minimum of 9 mm in thickness; or (ii) steel sheeting; or (iii) a combination of Items (i) and (ii) above.</p> <p>or (c) A system complying with AS 1530.8.1. or (d) A combination of any of Items (a), (b) or (c) above.</p> <p>Joints All joints in the external surface material of walls shall be covered, sealed, overlapped, backed or butt-jointed to prevent gaps greater than 3 mm.</p> <p>Alternatively, sarking-type material may be applied over the frame prior to fixing any external cladding.</p> <p>Vents and weepholes Vents and weepholes in external walls shall be screened with a mesh with a maximum aperture of 2 mm, made of corrosion-resistant steel or bronze except where they are less than 3 mm (see Clause 3.6).</p> <p>NOTE A system with an FRL of 30/30/30 or -/30/30 when tested from the outside also complies with BAL-40. See HardieSmart™ wall systems, figures 3 & 4</p>	<p>For James Hardie external cladding 6-8mm, a HardieSmart™ Boundary wall system is required.</p> <p>Please refer to figure 3 in this guide.</p> <p>For James Hardie external cladding 9mm and above including EasyLap™ Panels no additional requirements are needed. Refer to the respective product install guide for installation.</p> <p>NOTE EasyLap™ Panels have also been approved when installed as per the current installation manual.</p>

**BUILDING IN BUSHFIRE-PRONE AREAS IN ACCORDNACE WITH AS 3959:
2009 – RELATED TO FIBRE CEMENT IN FLOOR AND EXTERNAL WALLS ONLY**

Building Element	Australian Standard 3959: 2009 Requirement	James Hardie Recommendations
CONSTRUCTION FOR BUSHFIRE ATTACK LEVEL BAL FZ		
FLOORS	<p>FLOORS</p> <p>Concrete slabs on ground This Standard does not provide construction requirements for concrete slabs on ground.</p> <p>Elevated floors Enclosed subfloor spaces This Standard does not provide construction requirements for elevated floors, including bearers, joists and flooring, where the subfloor space is enclosed with a wall that complies with Clause 9.4.</p> <p>Unenclosed subfloor spaces Where the subfloor space is unenclosed, the floor system, including bearers, joist and flooring, shall:</p> <p>(a) have an FRL of at least 30/30/30 and the surface material shall be non-combustible (e.g., concrete, steel); or (b) have the underside of the combustible elements of the floor system protected with a 30 min resistance to incipient spread of fire system; or (c) comply with AS 1530.8.2 when tested from the underside; or (d) be a combination of any of Items (a), (b) or (c) above.</p> <p>Decking Decking shall have no gaps and be:</p> <p>(a) of non-combustible material; or (b) fibre-cement sheet; or (c) a system complying with AS 1530.8.2; or (d) a combination of Items (a), (b) or (c) above</p>	<p>All James Hardie flooring products are deemed non-combustible in accordance with BCA section C1.9.</p> <p>James Hardie flooring products include:</p> <ul style="list-style-type: none"> ■ Scyon™ Secura™ interior flooring ■ Scyon™ Secura™ Exterior flooring ■ HardiePanel™ compressed sheets ■ HardieDeck™
EXTERNAL WALLS	<p>9.4 EXTERNAL WALLS</p> <p>9.4.1 Walls Walls shall be one of the following:</p> <p>(a) Walls made of non-combustible material (e.g., masonry, brick veneer, mud brick, aerated concrete, concrete) with a minimum of 90 mm in thickness. or (b) A system complying with AS 1530.8.2 when tested from the outside. or (c) A system with an FRL of 30/30/30 or -/30/30 when tested from the outside. or (d) A combination of any of Items (a), (b) or (c) above.</p> <p>9.4.2 Joints All joints in the external surface material of walls shall be covered, sealed, overlapped, backed or butt-jointed to prevent gaps greater than 3 mm. Alternatively, sarking-type material may be applied over the frame prior to fixing any external cladding.</p> <p>9.4.3 Vents and weepholes Vents and weepholes in external walls shall be screened with a mesh with a maximum aperture of 2 mm, made of corrosion-resistant steel or bronze, except where they are less than 3 mm (see Clause 3.6).</p>	<p>A 30/30/30 Wall FRL can be achieved with James Hardie external cladding when using HardieSmart™ Boundary Wall system or other available fire systems. See Figures 3 and 4 for more information.</p>

Typical Applications

Walls/Floors

Up to and including BAL 40

There are requirements in certain cases where the sub-floor space must be fully enclosed with non-combustible material (for which fibre cement is suitable). There are also cases where the floor must be sheeted underneath with a fire-retardant-treated (FRT) timber or a non-combustible material (for which fibre cement is suitable). In both cases the minimum required thickness of the fibre cement is 6mm.

For the following details please refer to Table 1 for product suitability and the current James Hardie product literature for installation instructions.

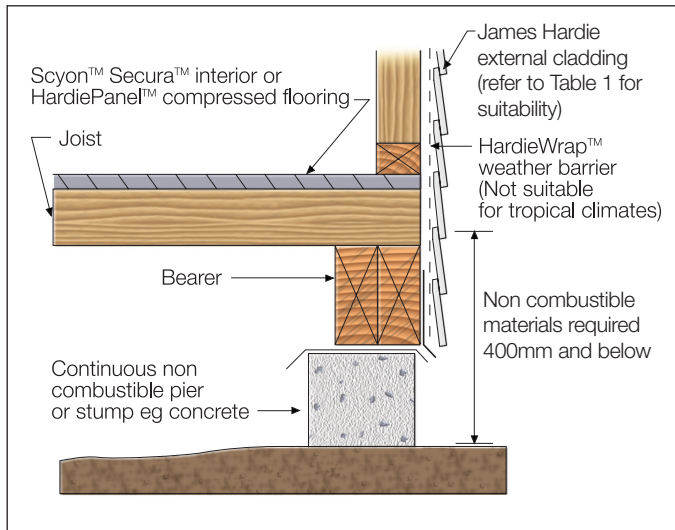

FIGURE 1: NON COMBUSTIBLE FLOOR DETAIL

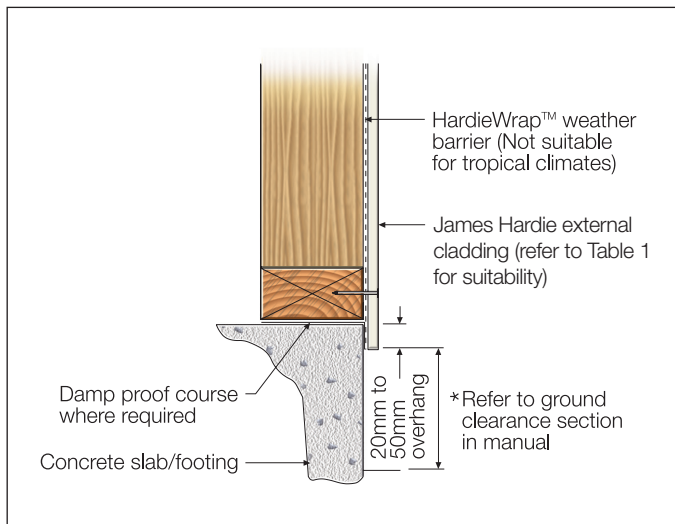

FIGURE 2: SLAB ON GROUND DETAIL-NON COMBUSTIBLE ONLY

FIRE RATED WALL - 30/30/30 for BAL-FZ (HardieSmart Boundary Wall System)

For installation, construction and suitability please refer to HardieSmart Boundary wall system Design Guide available at www.jameshardie.com.au or www.accel.com.au

When a minimum 90x45mm wall frame is constructed at 600mm maximum stud centres using the below external and internal wall configuration, it will satisfy a 30/30/30 one way fire rating from the outside.

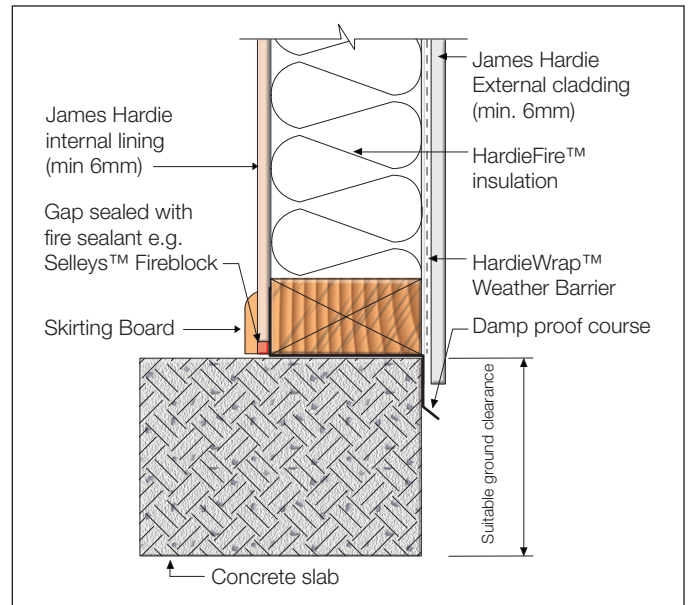

FIGURE 3: 30/30/30 ONE WAY FRL ALIGNED - HARDIESMART™ WALL SYSTEM - OPTION 1

FIRE RATED WALL-30/30/30 For BAL-FZ

When a minimum 90x45mm wall frame is constructed at 600mm maximum stud centres using the below external and internal wall configuration, it will satisfy a 30/30/30 one way fire rating from the outside.

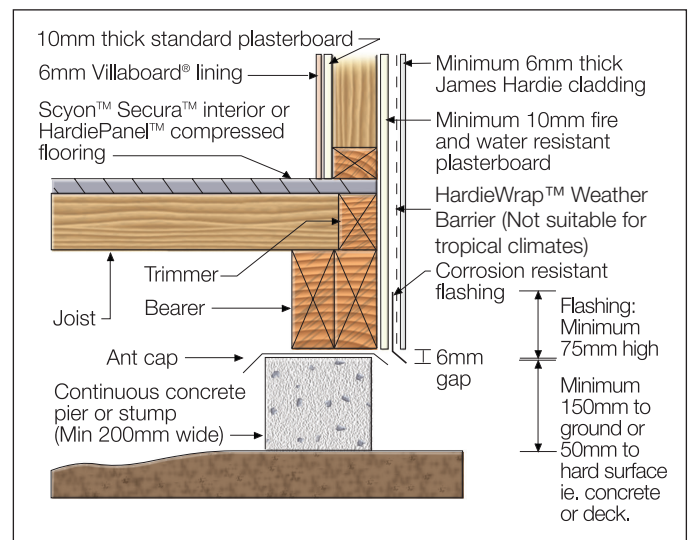

FIGURE 4A: 30/30/30 ONE WAY FRL OVERHANG FOOTING - OPTION 2

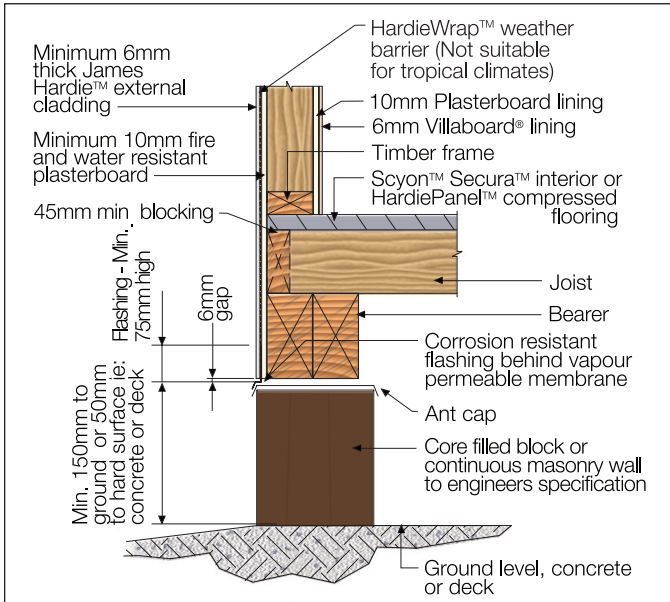

FIGURE 4B: 30/30/30 ONE WAY FRL ALIGNED - OPTION 3

Eaves

The roof/wall junction must be sealed by either the use of fascia or eaves linings or by sealing between the rafters at the line of the wall. All other types of roofing must be constructed to ensure that burning embers do not penetrate into the roof space.

BAL Requirement

BAL LOW	No construction requirement but min. 4.5 mm fibre cement sheet is recommended
BAL 12.5	No construction requirement but min. 4.5 mm fibre cement sheet is recommended
BAL 19	No construction requirement but min. 4.5 mm fibre cement sheet is recommended
BAL 29	Minimum 4.5 mm fibre cement sheet
BAL 40	Minimum 6 mm fibre cement sheet
BAL FZ	A system with a FRL or -/30/30. See Figure 5.

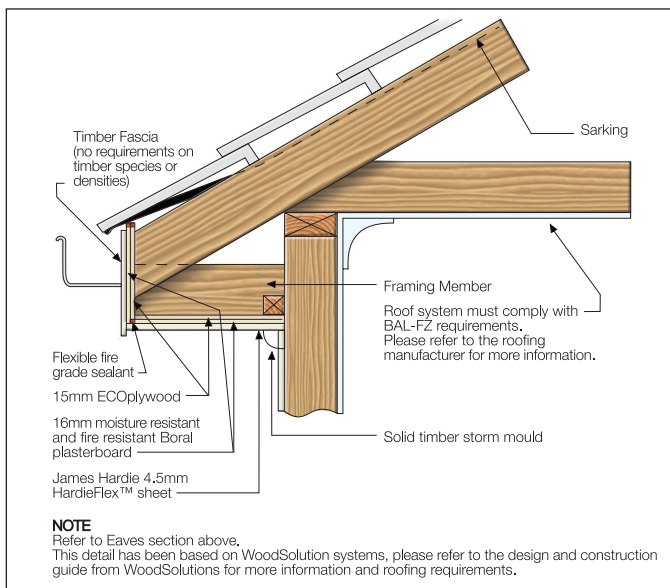

FIGURE 5: FIRE RATED EAVE DETAIL (FRL -/30/30)

* Framing to be at maximum 450mm centres.

15mm ECOplywood sheet Layer:

- All 15mm ECOplywood joints must fall on framing members or steel angles at fascia or at wall.
- 15mm ECOplywood sheets must be fixed to framing members at 200mm maximum centres with screws that are a minimum 50mm long.

16mm Boral Firestop plasterboard sheet layer:

- Boral Firestop plasterboard butt joints must not coincide with the 15mm ECOplywood joints.
- Boral Firestop plasterboard to be fixed to the framing at 150mm maximum centres around the perimeter, as well as at 200mm max centre spacing along framing.
- Plasterboard fastener to be plasterboard screws.

James Hardie 4.5mm HardieFlex sheet layer:

- James Hardie 4.5mm HardieFlex sheets can be butt jointed or joined with PVC jointers on framing only.
- James Hardie 4.5mm HardieFlex sheets cannot be joined off framing.
- The fastener recommended in the HardieFlex lining installation manual must be increased by 31mm minimum to allow for the additional layers behind the HardieFlex lining.
- James Hardie 4.5mm HardieFlex sheets must be installed in accordance with the current James Hardie Eave & Soffit Technical Specification.

For more information please refer to the relevant James Hardie™ installation manuals, www.jameshardie.com.au or call 131 103 and speak to a service representative.

Deck: Sub floor enclosed

For BAL 40 on FZ only steel and concrete sub framing is allowed.

TABLE 1 BUSHFIRE PRONE AREAS REQUIREMENTS FOR DECKS				
DESIGN CRITERIA (AS 4055: 2014)	BUSHFIRE ATTACK LEVEL (BAL)			
	12.5 & 19	29	40	Flame Zone (FZ)
Decking Boards	HardieDeck™ suitable			
Framing and Supports	No additional requirements	Non-combustible (e.g. steel) or bushfire suitable resisting timber	Non-combustible (e.g. steel) or system compliant with AS 1530.8.1 (no bushfire timber allowed)	
Balustrade & Handrail	No additional requirements	Varies based on distance from glazed element or combustible material. <125mm, It must be non-combustible material or bushfire timber >125mm, no additional requirements		

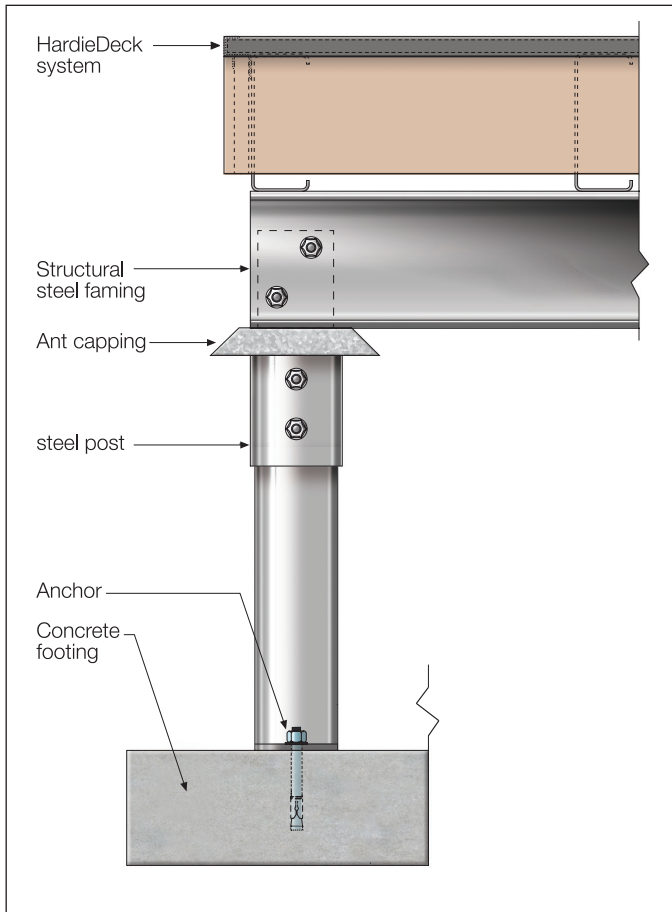

FIGURE 6: STEEL PIER AND STEEL SUB FRAMING - OPTION 1

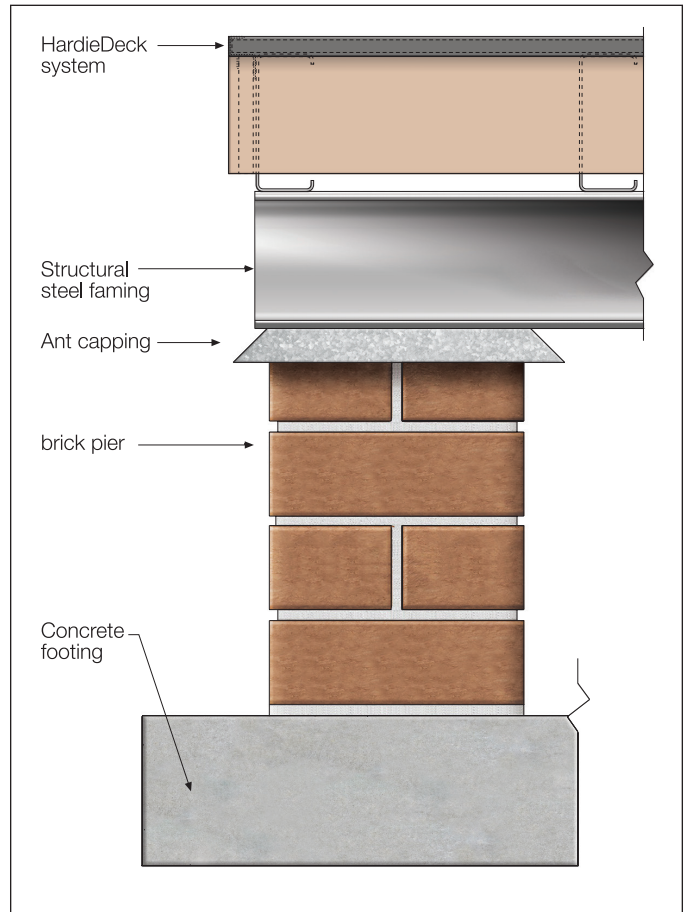

FIGURE 7: MASONRY PIER AND STEEL SUB FRAMING - OPTION 2

NOTES